

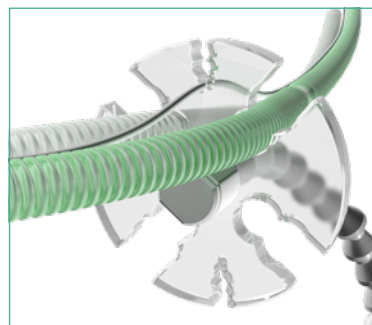

Tube management programme

Help to provide a safe and tidy environment reducing the risk of disconnection and patient trauma.

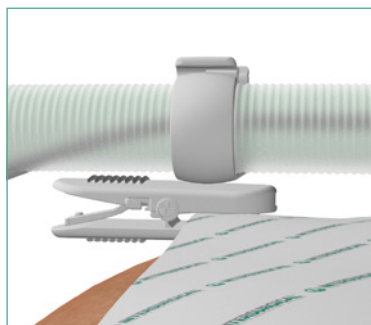

Critical Care ▪ Accessories

Tube management programme

When used in conjunction with Intersurgical breathing systems our full range of tube management options allow the clinician to position our products efficiently and comfortably around the patient area. These help to provide a safe and tidy environment reducing the risk of disconnection and patient trauma.

Intersurgical tube clips, 22F red safety cap, humidification chamber fill set spike cover, and tube clip hanger are designed to interface with the tube management clip or grip via a notch feature.

Tube clips are available to fit our Smoothbore and Flextube™ breathing systems with options available for 10mm, 15mm, 22mm and 30mm single and dual limb breathing systems.

▶ Video available at www.intersurgical.com

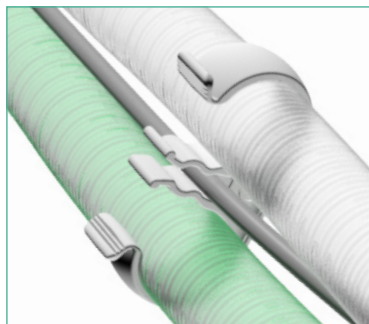
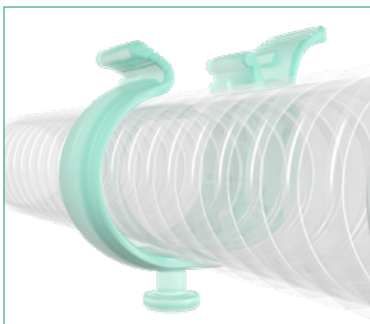
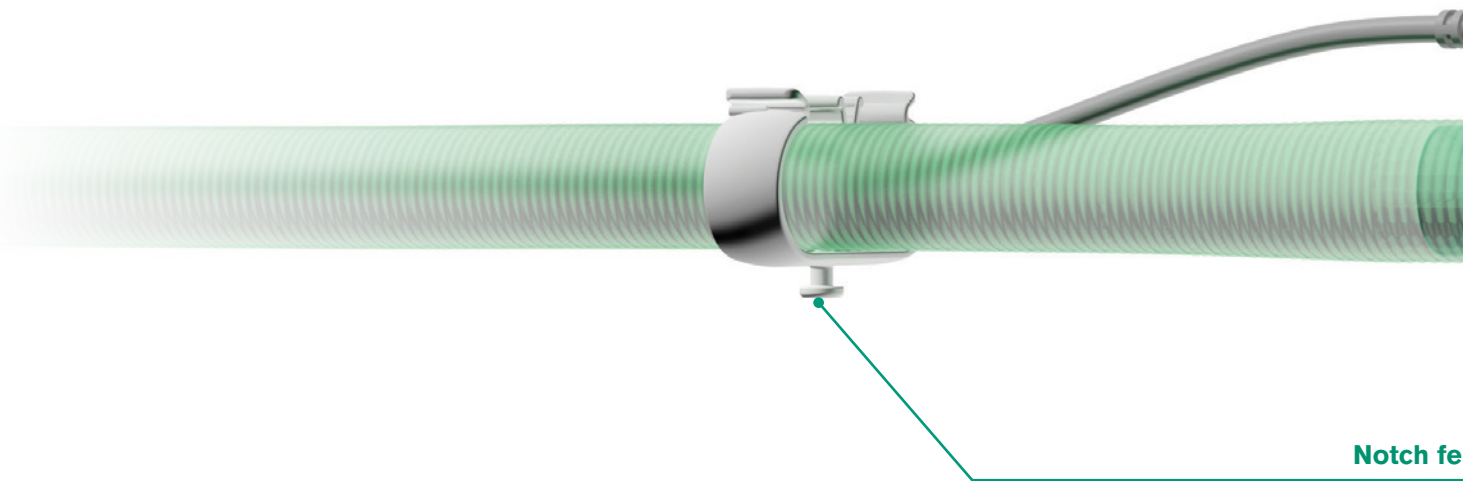

Tube clips 10mm, 15mm, 22mm, 30mm

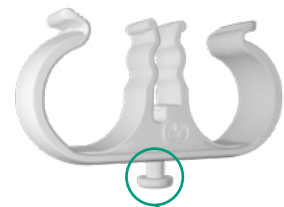

Notch feature

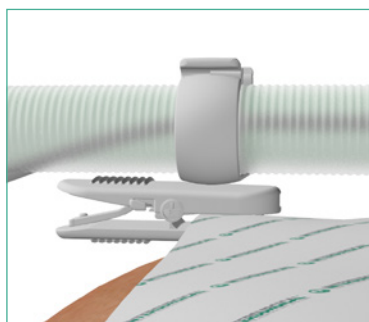

Tube management grip



Tube support

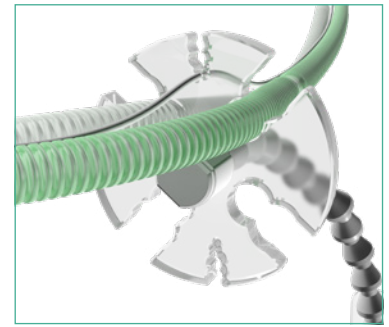
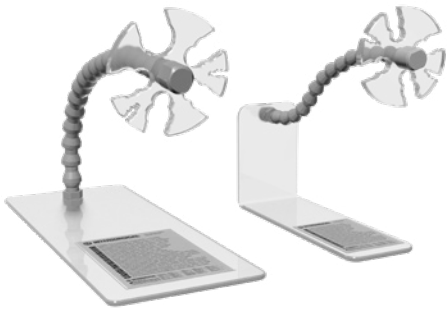

Our ergonomically designed tube support is a neat way of securely holding a breathing system close to the patient. Available in two sizes the tube support efficiently holds in place 10, 15, 22 and 30mm tubes with a smaller groove to grip monitoring lines and cables. The flexible neck is easily positioned to take the strain of the breathing system away from the patient.

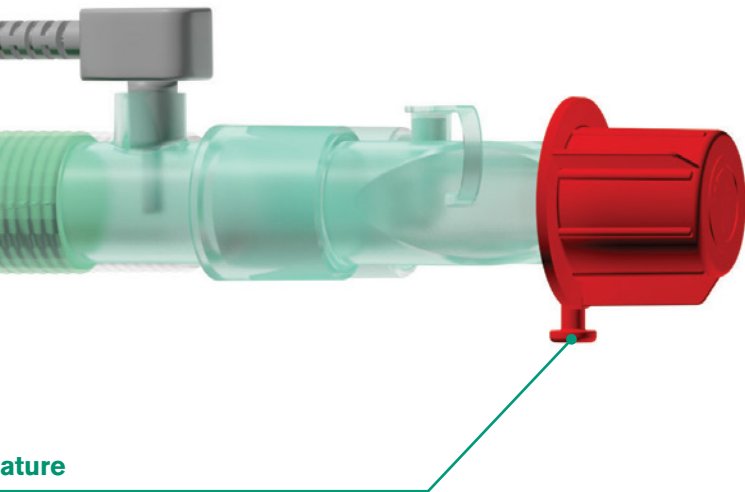

Red safety cap or humidification chamber fill set spike cover



interfaces with



Tube management clip



Tube management guide

Flextube™ and Smoothbore tube clip



Code 2317000
Box Qty. 25

Flextube tube clip



Code 2315000
Box Qty. 25

Smoothbore tube clip

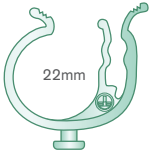

Code 2318000
Box Qty. 25

Flextube tube clip

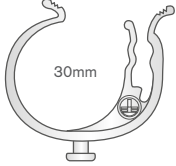

Code 2319000
Box Qty. 25

Flextube and Smoothbore tube clip

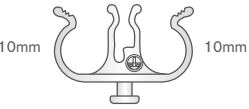

Code 2311000
Box Qty. 25

Flextube and Smoothbore tube clip

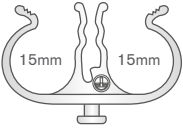

Code 2312000
Box Qty. 25

Flextube tube clip

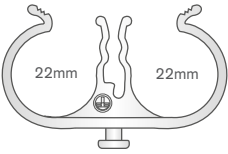

Code 2313000
Box Qty. 25

Smoothbore tube clip

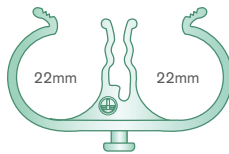

Code 2314000
Box Qty. 25

Tube management clips

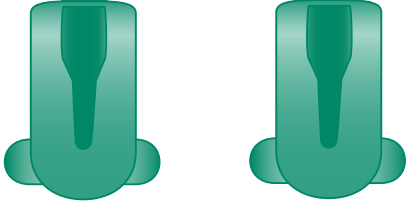

Tube clips



Code 2316000
Box Qty. 12

▶ Video available at www.intersurgical.com

Make an enquiry

Tube support 30mm/22mm/15mm



Code 5904000
Box Qty. 1

Tube support 15mm/10mm



Code 5905000
Box Qty. 1

Tube management grip



Code 2321000
Box Qty. 50

Tube clip hanger

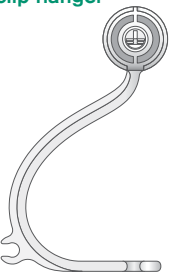

Code 5572000
Box Qty. 25

Make an enquiry

INTERSURGICAL COMPLETE RESPIRATORY SYSTEMS
Intersurgical Ltd, Crane House, Molly Millars Lane, Wokingham, Berkshire, RG41 2RZ, UK
T: +44 (0)118 965 6300 F: +44 (0)118 965 6356 info@intersurgical.com www.intersurgical.com



The manufacturer Intersurgical Ltd is certified to ISO 9001:2015, ISO 13485:2016 and ISO 14001:2015

Please think before you print
Save energy and paper.
If you must print this information sheet please print it double sided.