



PHILIPS

Hospital
respiratory care







Confidence in your patient's comfort

Philips Respironics patient interfaces and circuits for noninvasive ventilation

Delivering **exceptional** NIV

Philips Respironics masks are designed to support enhanced NIV. From comfort for your patients to ease of use for you, our interfaces are specially designed to meet the rigors of acute care environments.

Table of contents

	Total face masks	4
	Oro-nasal masks	8
	Nasal masks	16
	Packs and accessories	20
	Circuits and connections	28
	Trilogy accessories	30

Total face masks

Total face masks allow quick fitting and eliminate nasal bridge challenges by sealing around the perimeter of the face, where patients have less pressure sensitivity and smoother facial contours.

Mask selection criteria

- Rapid application
- Mouth breather
- Facial abnormalities
- Lack of teeth





Philips Respironics Total



Key benefits

- Clear, unobstructed view
- Perimeter facial contact increases comfort and simplifies fitting
- Digital Auto-Trak compatibility enhances NIV performance

For headgear, see page 25

Total

Philips Respironics Total multi-use

Description	Quantity	Product number	Part number
Total face mask	1	302433	989805609231
Total face mask head strap	1	1003052	453561517111
Total face mask head strap	9	1010609	989805610031



Philips Respironics PerforMax single-use



Key benefits

- Available for patients 7 years or older and > 20 kg (40 lb)
- Perimeter facial contact increases comfort and simplifies fitting
- Clear, unobstructed view

Compatible with a leak 2 entrainment elbow (EE), standard elbow (SE), and bronchoscopy elbow (BE)
 For accessories, see page 24
 For headgear, see page 25

PerforMax EE leak 2

Philips Respironics PerforMax single-use

Description	Quantity	Product number	Part number
PerforMax with EE leak 2 elbow, small*†	1	1061619	989805627831
PerforMax with EE leak 2 elbow, large†	1	1061620	989805627841
PerforMax with EE leak 2 elbow, extra large†	1	1080426	989805634831
PerforMax with EE leak 2 elbow, small*†	10	1052535	989805611281
PerforMax with EE leak 2 elbow, large†	10	1052536	989805611291
PerforMax with EE leak 2 elbow, extra large†	5	1080424	989805634811
PerforMax with SE standard elbow, small*†	1	1061621	989805627851
PerforMax with SE standard elbow, large†	1	1061622	989805627861
PerforMax with SE standard elbow, extra large†	1	1080517	989805634841
PerforMax with SE standard elbow, small*†	10	1052547	989805611301
PerforMax with SE standard elbow, large†	10	1052548	989805611311
PerforMax with SE standard elbow, extra large†	5	1080425	989805634821

* Intended for use by patients 7 years or older and > 20 kg (40 lb)

† Not available in all markets, please contact your Philips sales consultant.



Philips Respironics PerforMax multi-use



Key benefits

- Available for patients 7 years or older and > 20 kg (40 lb)
- Perimeter facial contact supports comfort and simplifies fitting
- Clear, unobstructed view

Compatible with a leak 2 entrainment elbow (EE), standard elbow (SE), and bronchoscopy elbow (BE)
 For accessories, see page 24
 For headgear, see page 25

PerforMax SE

Philips Respironics PerforMax multi-use

Description	Quantity	Product number	Part number
PerforMax with EE leak 2 and SE elbow, small*	1 mask/4 headgear	1052553	989805611361
PerforMax with EE leak 2 and SE elbow, large	1 mask/4 headgear	1052554	989805611371
PerforMax with EE leak 2 and SE elbow, extra large	1 mask/4 headgear	1080420	989805634771
PerforMax with EE leak 2, small*	1 mask/4 headgear	1052555	989805611381
PerforMax with EE leak 2, large	1 mask/4 headgear	1052556	989805611391
PerforMax with EE leak 2, extra large	1 mask/4 headgear	1080421	989805634781
PerforMax with SE standard elbow, small*	1 mask/4 headgear	1052568	989805611401
PerforMax with SE standard elbow, large	1 mask/4 headgear	1052569	989805611411
PerforMax with SE standard elbow, extra large	1 mask/4 headgear	1080422	989805634791
PerforMax with EE leak 2 and SE elbow, small*	1 mask/1 headgear	1044385	989805611091
PerforMax with EE leak 2 and SE elbow, large	1 mask/1 headgear	1044386	989805611101
PerforMax with EE leak 2 and SE elbow, extra large	1 mask/1 headgear	1080423	989805634801

* Intended for use by patients 7 years or older and > 20 kg (40 lb)

Oro-nasal masks

Oro-nasal masks are the standard of care for hospital NIV, and the Philips Respironics family includes a comprehensive selection of systems with features that address patient comfort, mask fitting, and ventilator compatibility.

Patient comfort made easy

CapStrap headgear provides excellent stability and simplifies initial setup by keeping the mask in place while you adjust the patient's straps. When you need to interrupt treatment for oral care and medications, the CapStrap headgear allows quick removal and simple reapplication. CapStrap headgear is available on several Philips Respironics masks:

- AF541
- AF531
- AF811
- PerformaTrak

Mask selection criteria

- Mouth breather
- Long-term NIV
- Two cushion styles for mask rotation



Philips Respironics AF541



AF541 with four-point headgear, EE leak 1

Key benefits

- The under-the-nose cushion can be used to off load mask pressure at bridge of nose
- Push-button forehead pad adjustment, easy-to-use CapStrap headgear, and snap-in-place elbows and talon clips contribute to efficient workflow
- Discharge kit configures mask to work with home NIV systems
- CleanClip system supports your infection control efforts
- Discharge kit for patient transition to lower acuity setting

For accessories, see page 24
For headgear, see page 25

Philips Respironics AF541

Description	Quantity	Product number	Part number
AF541 with EE leak 1 elbow, CapStrap headgear, small*	10	1120925	989805653931
AF541 with EE leak 1 elbow, CapStrap headgear, medium*	10	1120926	989805653941
AF541 with EE leak 1 elbow, CapStrap headgear, large	10	1120927	989805653951
AF541 with EE leak 1 elbow, CapStrap headgear, extra large	10	1120928	989805653961
AF541 with EE leak 2 elbow, CapStrap headgear, small*	10	1120935	989805654011
AF541 with EE leak 2 elbow, CapStrap headgear, medium*	10	1120936	989805654021
AF541 with EE leak 2 elbow, CapStrap headgear, large	10	1120937	989805654031
AF541 with EE leak 2 elbow, CapStrap headgear, extra large	10	1120938	989805654041
AF541 with SE standard elbow, CapStrap headgear, small*	10	1120945	989805654091
AF541 with SE standard elbow, CapStrap headgear, medium*	10	1120946	989805654101
AF541 with SE standard elbow, CapStrap headgear, large	10	1120947	989805654111
AF541 with SE standard elbow, CapStrap headgear, extra large	10	1120948	989805654121
AF541 with EE leak 1 elbow, four-point headgear, small*	10	1120920	989805653891
AF541 with EE leak 1 elbow, four-point headgear, medium*	10	1120921	989805653901
AF541 with EE leak 1 elbow, four-point headgear, large	10	1120922	989805653911
AF541 with EE leak 1 elbow, four-point headgear, extra large	10	1120923	989805653921
AF541 with EE leak 2 elbow, four-point headgear, small*	10	1120930	989805653971
AF541 with EE leak 2 elbow, four-point headgear, medium*	10	1120931	989805653981
AF541 with EE leak 2 elbow, four-point headgear, large	10	1120932	989805653991
AF541 with EE leak 2 elbow, four-point headgear, extra large	10	1120933	989805654001
AF541 with SE standard elbow, four-point headgear, small*	10	1120940	989805654051
AF541 with SE standard elbow, four-point headgear, medium*	10	1120941	989805654061
AF541 with SE standard elbow, four-point headgear, large	10	1120942	989805654071
AF541 with SE standard elbow, four-point headgear, extra large	10	1120943	989805654081
AF541 size A under-the-nose cushion	10	1120980	989805654271
AF541 size B under-the-nose cushion	10	1120981	989805654281
AF541 size C under-the nose cushion	10	1120982	989805654291
Bronchoscopy elbow	5	1120984	989805654301
AF541 discharge kit, CapStrap headgear, small/medium	5	1120986	989805654311
AF541 discharge kit, CapStrap headgear, large/extra large	5	1120988	989805654331
AF541 discharge kit, four-point headgear, small/medium	5	1120987	989805654321
AF541 discharge kit, four-point headgear, large/extra large	5	1120989	989805654341

* Intended for use by patients 7 years or older and > 20 kg (40 lb)





Philips Respironics AF531



AF531 with CapStrap



AF531 EE leak 1 elbow

Key benefits

- CapStrap headgear provides an excellent fit and simple reapplication
- Supports your infection control efforts with the CleanClip system
- You can adapt one mask to multiple ventilators with interchangeable elbows

Compatible with a leak 1 or leak 2 entrainment elbow (EE), EE NIVO elbow (EE/NE), standard elbow (SE), SE NIVO elbow (SE/NE), and bronchoscopy elbow (BE)
 For accessories, see page 24
 For headgear, see page 25

Philips Respironics AF531 with CapStrap single-use

Description	Quantity	Product number	Part number
AF531 with EE leak 1 elbow, CapStrap headgear, small*	1	1061727	989805628611
AF531 with EE leak 1 elbow, CapStrap headgear, medium	1	1061728	989805628621
AF531 with EE leak 1 elbow, CapStrap headgear, large	1	1061729	989805628631
AF531 with EE leak 1 elbow, CapStrap headgear, small*	10	1072627	989805628731
AF531 with EE leak 1 elbow, CapStrap headgear, medium	10	1072628	989805628741
AF531 with EE leak 1 elbow, CapStrap headgear, large	10	1072629	989805628751
AF531 with SE standard elbow, CapStrap headgear, small*	1	1061730	989805628641
AF531 with SE standard elbow, CapStrap headgear, medium	1	1061731	989805628651
AF531 with SE standard elbow, CapStrap headgear, large	1	1061732	989805628661
AF531 with SE standard elbow, CapStrap headgear, small*	10	1072630	989805628761
AF531 with SE standard elbow, CapStrap headgear, medium	10	1072631	989805628771
AF531 with SE standard elbow, CapStrap headgear, large	10	1072632	989805628781
AF531 with EE leak 1/NE nebulizer elbow, CapStrap headgear, small*	10	1072636	989805635001
AF531 with EE leak 1/NE nebulizer elbow, CapStrap headgear, medium	10	1072637	989805635011
AF531 with EE leak 1/NE nebulizer elbow, CapStrap headgear, large	10	1072638	989805635021

* Intended for use by patients 7 years or older and > 20 kg (40 lb)



Philips Respironics AF531



AF531 with four-point headgear, EE leak 1



AF531 Bronchoscopy elbow*



AF531 SE standard elbow

Key benefits

- Supports your infection control efforts with the CleanClip system
- You can adapt one mask to multiple ventilators with interchangeable elbows

For accessories, see page 24

For headgear, see page 25

Philips Respironics AF531 with four-point headgear single-use

Description	Quantity	Product number	Part number
AF531 with EE leak 1 elbow, four-point headgear, small**	1	1061718	989805628521
AF531 with EE leak 1 elbow, four-point headgear, medium	1	1061719	989805628531
AF531 with EE leak 1 elbow, four-point headgear, large	1	1061720	989805628541
AF531 with EE leak 1 elbow, four-point headgear, small**	10	1072621	989805628671
AF531 with EE leak 1 elbow, four-point headgear, medium	10	1072622	989805628681
AF531 with EE leak 1 elbow, four-point headgear, large	10	1072623	989805628691
AF531 with SE standard elbow, four-point headgear, small**	1	1061721	989805628551
AF531 with SE standard elbow, four-point headgear, medium	1	1061722	989805628561
AF531 with SE standard elbow, four-point headgear, large	1	1061723	989805628571
AF531 with SE standard elbow, four-point headgear, small**	10	1072624	989805628701
AF531 with SE standard elbow, four-point headgear, medium	10	1072625	989805628711
AF531 with SE standard elbow, four-point headgear, large	10	1072626	989805628721
AF531 with EE leak 1 nebulizer elbow, four-point headgear, small**	10	1061633	989805634971
AF531 with EE leak 1 nebulizer elbow, four-point headgear, medium	10	1061634	989805634981
AF531 with EE leak 1 nebulizer elbow, four-point headgear, large	10	1061635	989805634991

* Bronchoscopy elbow sold separately, see page 24

** Intended for use by patients 7 years or older and > 20 kg (40 lb)



Philips Respironics AF531 with leak 2 elbow



Key benefits

- Leak built into the mask
- Can be used without an additional exhalation port
- Available with four point headgear and CapStrap headgear
- Convenient ten-packs

For accessories, see page 24
For headgear, see page 25

AF531 EE leak 2

Philips Respironics AF531 with leak 2 elbow single-use

Description	Quantity	Product number	Part number
AF531 with EE leak 2 elbow, four-point headgear, small*	1	1061724	989805628581
AF531 with EE leak 2 elbow, four-point headgear, medium	1	1061725	989805628591
AF531 with EE leak 2 elbow, four-point headgear, large	1	1061726	989805628601
AF531 with EE leak 2 elbow, four-point headgear, small*	10	1100393	989805645651
AF531 with EE leak 2 elbow, four-point headgear, medium	10	1100394	989805645661
AF531 with EE leak 2 elbow, four-point headgear, large	10	1100395	989805645671
AF531 with EE leak 2 elbow, CapStrap headgear, small*	10	1100390	989805645621
AF531 with EE leak 2 elbow, CapStrap headgear, medium	10	1100391	989805645631
AF531 with EE leak 2 elbow, CapStrap headgear, large	10	1100392	989805645641

* Intended for use by patients 7 years or older and > 20 kg (40 lb)



Philips Respironics AF811



Key benefits

- Cushion uses a gel pad with a silicone flap for increased comfort
- CapStrap headgear system simplifies mask application and routine patient care
- Available in three sizes to fit a wide patient population

Entrainment elbow (EE)
 Also available with standard elbow (SE)
 For headgear, see page 25

AF811 EE

Philips Respironics AF811 single-use

Description	Quantity	Product number	Part number
AF811 oro-nasal mask EE, CapStrap headgear, small	1	1063047	989805626321
AF811 oro-nasal mask EE, CapStrap headgear, medium	1	1063016	989805626311
AF811 oro-nasal mask EE, CapStrap headgear, large	1	1063015	989805626301
AF811 oro-nasal mask EE, CapStrap headgear, small	5	1063053	989805626381
AF811 oro-nasal mask EE, CapStrap headgear, medium	5	1063052	989805626371
AF811 oro-nasal mask EE, CapStrap headgear, large	5	1063051	989805626361
AF811 oro-nasal mask SE, CapStrap headgear, small	1	1063050	989805626351
AF811 oro-nasal mask SE, CapStrap headgear, medium	1	1063049	989805626341
AF811 oro-nasal mask SE, CapStrap headgear, large	1	1063048	989805626331
AF811 oro-nasal mask SE, CapStrap headgear, small	5	1063056	989805626411
AF811 oro-nasal mask SE, CapStrap headgear, medium	5	1063055	989805626401
AF811 oro-nasal mask SE, CapStrap headgear, large	5	1063054	989805626391



Philips Respironics PerformaTrak



PerformaTrak

Key benefits

- Dual-density foam forehead pads provide patient comfort and mask stability
- With only three sizes, clinicians can quickly fit a wide range of patients
- Swivel clips simplify reapplication by reducing the need to refit after removal

Entrainment elbow (EE)
 Also available with standard elbow (SE)
 For headgear, see page 25

Philips Respironics PerformaTrak single-use

Description	Quantity	Product number	Part number
PerformaTrak oro-nasal mask EE leak 1, four-point headgear, small	1	1012573	989805610111
PerformaTrak oro-nasal mask EE leak 1, four-point headgear, medium	1	1012574	989805610121
PerformaTrak oro-nasal mask EE leak 1, four-point headgear, large	1	1012635	989805610151
PerformaTrak oro-nasal mask EE leak 1, four-point headgear, small	10	1018589	989805610481
PerformaTrak oro-nasal mask EE leak 1, four-point headgear, medium	10	1018590	989805610491
PerformaTrak oro-nasal mask EE leak 1, four-point headgear, large	10	1018591	989805610501
PerformaTrak oro-nasal mask SE, four-point headgear, small	1	1012639	989805610191
PerformaTrak oro-nasal mask SE, four-point headgear, medium	1	1012640	989805610201
PerformaTrak oro-nasal mask SE, four-point headgear, large	1	1012641	989805610211
PerformaTrak oro-nasal mask SE, four-point headgear, small	10	1018605	989805610581
PerformaTrak oro-nasal mask SE, four-point headgear, medium	10	1018606	989805610591
PerformaTrak oro-nasal mask SE, four-point headgear, large	10	1018595	989805610541
PerformaTrak oro-nasal mask with CapStrap EE, small	10	1019492	989805610691
PerformaTrak oro-nasal mask with CapStrap EE, medium	10	1019498	989805610701
PerformaTrak oro-nasal mask with CapStrap EE, large	10	1019507	989805610711
PerformaTrak oro-nasal mask with CapStrap SE, small	10	1019540	989805610811
PerformaTrak oro-nasal mask with CapStrap SE, medium	10	1019541	989805610821
PerformaTrak oro-nasal mask with CapStrap SE, large	10	1019542	989805610831

Philips Respironics PerformaTrak multi-use

Description	Quantity	Product number	Part number
PerformaTrak oro-nasal mask EE leak 1, four-point headgear, small	1	1022980	989805610871
PerformaTrak oro-nasal mask EE leak 1, four-point headgear, medium	1	1023022	989805610881
PerformaTrak oro-nasal mask EE leak 1, four-point headgear, large	1	1023023	989805610891
PerformaTrak SE oro-nasal mask, four-point-headgear, small	1	1023025	989805610901
PerformaTrak SE oro-nasal mask, four-point-headgear, medium	1	1023026	989805610911
PerformaTrak SE oro-nasal mask, four-point-headgear, large	1	1023027	989805610921
PerformaTrak four-point headgear assembly with forehead pad	5	1022453	989805610861



Philips Respironics AF421



AF421 with four-point headgear, SE



AF421 EE leak 1



AF421 EE leak 2

Key benefits

- Supports your infection control efforts with CleanClip
- Oral access feature for oral care
- Leak symbols for ease of ventilator setup
- Available with EE leak 1, SE standard elbow, and EE leak 2 elbow for wide ventilator application
- Available in four sizes to fit a wide patient population

Philips Respironics AF421

Description	Quantity	Product number	Part number
AF421 with EE leak 1 elbow, small*	10 pack	1106170	989805648331
AF421 with EE leak 1 elbow, medium	10 pack	1106171	989805648341
AF421 with EE leak 1 elbow, large	10 pack	1106172	989805648351
AF421 with EE leak 1 elbow, extra large	10 pack	1106173	989805648361
AF421 with SE standard elbow, small*	10 pack	1106174	989805648371
AF421 with SE standard elbow, medium	10 pack	1106175	989805648381
AF421 with SE standard elbow, large	10 pack	1106176	989805648391
AF421 with SE standard elbow, extra large	10 pack	1106177	989805648401
AF421 with EE leak 2 elbow, small*	10 pack	1106178	989805648411
AF421 with EE leak 2 elbow, medium	10 pack	1106179	989805648421
AF421 with EE leak 2 elbow, large	10 pack	1106180	989805648431
AF421 with EE leak 2 elbow, extra large	10 pack	1106181	989805648441
Accessory, AF421 forehead pad (3/4 in, 19.1 mm)	10 pack	1118318	989805652341
RP, S/M AF421 headgear with clips	5 pack	1109915	989805648851
RP, L/XL AF421 headgear with clips	5 pack	1109916	989805648861
RP, AF421 sizing gauge	25 pack	1109917	989805648871

* Intended for use by patients 7 years or older and > 20 kg (40 lb)

Nasal masks

When chronically ill patients enter the hospital in respiratory distress, they typically want an NIV interface as comfortable as what they use at home. They want an unobtrusive system to maintain quality of life during their hospital stay.



Mask selection criteria

- Oral access
- Long-term NIV





Philips Respironics PerformaTrak



Key benefits

- CapStrap headgear provides an excellent fit and simple reapplication
- With only three sizes, clinicians can quickly fit a wide range of patients
- Hook-n-loop grab tabs allow quick, easy removal and adjustment of headgear

For headgear, see page 25

PerformaTrak with CapStrap

Philips Respironics PerformaTrak

Description	Quantity	Product number	Part number
PerformaTrak single-use nasal mask, CapStrap headgear, petite	10	1048709	989805611181
PerformaTrak single-use nasal mask, CapStrap headgear, small	10	1048708	989805611171
PerformaTrak single-use nasal mask, CapStrap headgear, medium/large	10	1048710	989805611191



Philips Respironics Contour Deluxe



Key benefits

- Dual-density foam forehead pads provide patient comfort and mask stability
- With only three sizes, clinicians can quickly fit a wide range of patients
- Hook-n-loop grab tabs allow quick, easy removal and adjustment of headgear

For headgear, see page 25

Contour Deluxe

Philips Respironics Contour Deluxe single-use

Description	Quantity	Product number	Part number
Contour Deluxe nasal mask, four-point headgear, petite	5	1016980	989805610311
Contour Deluxe nasal mask, four-point headgear, small	5	1016697	989805610291
Contour Deluxe nasal mask, four-point headgear, medium/large	5	1016695	989805610271
Contour Deluxe nasal mask, four-point headgear, small	10	1016698	989805610301
Contour Deluxe nasal mask, four-point headgear, medium/large	10	1016696	989805610281



Philips Respironics AP111



Key benefits

- Easy sizing and fitting
- Complete kit for quick setup
- Clear field of vision
- Cradle style nasal cushion

For headgear, see page 25

AP111

Philips Respironics AP111 single-use

Description	Quantity	Product number	Part number
AP111 interface with cradles* leak 3	1	1062128	989805626481
AP111 interface with cradles* leak 3, circuit, and main flow filter	1	1062130	989805626491
AP111 interface with cradles* leak 3, circuit, and main flow filter	5	1062132	989805626501

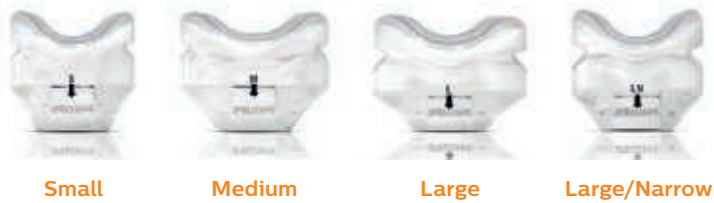

* Each Philips Respironics AP111 interface includes all four cushion sizes

Procedure packs and accessories

Get everything you need in one bundle with our procedure packs, designed to simplify the ordering process and help you work more efficiently.

These accessories help you customize your care to suit each individual patient, large or small.



Procedure packs

Description	Quantity	Product number	Part number
AF531 mask with EE leak 1 nebulizer elbow (no nebulizer), CapStrap headgear, and FEP circuit with main flow filter (#1)			
Small*	5	1072642	989805634651
Medium	5	1072643	989805634661
Large	5	1072644	989805634671
AF531 mask with EE leak 1 entrainment elbow, four-point headgear, and FEP circuit with main flow filter[†]			
Small*	5	1072639	989805626511
Medium	5	1072640	989805628811
Large	5	1072641	989805628821
AF811 gel mask with EE leak 1 entrainment elbow, CapStrap headgear, and FEP circuit with main flow filter and exhalation filter[†]			
Small	5	1074839	989805633171
Medium	5	1074838	989805633161
Large	5	1074837	989805633151
AF811 gel mask with EE leak 1 entrainment elbow, CapStrap headgear, and FEP circuit with main flow filter[†]			
Small	5	1074061	989805633201
Medium	5	1074060	989805633191
Large	5	1074059	989805633181
PerformaTrak mask with EE leak 1 entrainment elbow, four-point headgear, and FEP circuit with main flow filter[†]			
Small	5	1074055	989805633111
Medium	5	1074054	989805633101
Large	5	1074053	989805633091
PerformaTrak mask with EE leak 1 entrainment elbow, CapStrap headgear, and FEP circuit with main flow filter[†]			
Small	5	1074058	989805633141
Medium	5	1074057	989805633131
Large	5	1074056	989805633121

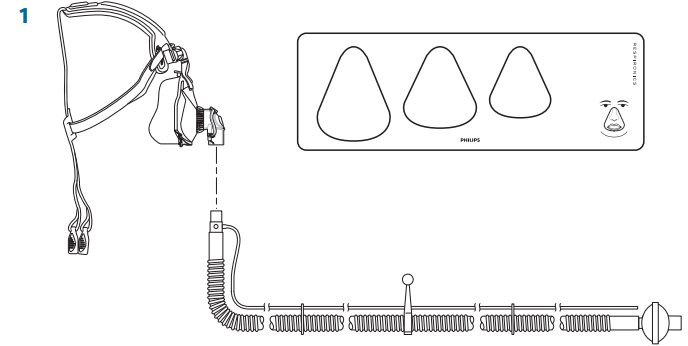

* Intended for use by patients 7 years or older and > 20 kg (40 lb)

[†] Not illustrated

Note: FEP – Filter Exhalation Port

Procedure packs (continued)

Description	Quantity	Product number	Part number
PerformaTrak mask, NIV circuit (9624C) with main flow filter, O₂ enrichment port[†]			
Small	10	1004228	989805618031
Medium	10	1004229	989805618041
Large	10	1004253	989805618051
PerformaTrak mask, heated single limb circuit with main flow filter, auto-feed humidification chamber[†]			
Small	10	1004198	989805618001
Medium	10	1004199	989805618011
Large	10	1004227	989805618021

Starter packs

Description	Quantity	Product number	Part number
Philips EE starter kit, oro-nasal and full face, multi-use[†]		1074044	989805626551
PerformaTrak EE, small/medium/large mask	3		
PerformaTrak with CapStrap headgear, EE, small/medium/large mask	3		
AF811 with CapStrap headgear, EE, small/medium/large mask	3		
PerforMax multi-use, EE/SE, four-point headgear, small/large	2		
NIV circuit with DEP filter and main flow filter	10		
Philips basic start kit, oro-nasal (1 mask)[†]		1074050	989805626611
PerformaTrak SE, small/medium/large mask	3		

[†] Not illustrated

Aerogen Pro-X controllers and systems

NIVO Pro-X controller kits*

Description	Quantity	Product number	Part number
NIVO Pro-X controller kit – Eng EU (English, EU plug)	1	1079421	989805634331
NIVO Pro-X controller kit – Northern EU (German, French, Dutch, Italian)	1	1082693	989805634471
NIVO Pro-X controller kit – Southern EU (Spanish, Italian, Portuguese, Greek)	1	1082694	989805634481
NIVO Pro-X controller kit – Scand EU (Norwegian, Swedish, Danish)	1	1082695	989805634491
NIVO Pro-X controller kit – UK/IE (English)	1	1079422	989805634341
NIVO Pro-X controller kit – AU/NZ (English)	1	1079423	989805634351
NIVO Pro-X controller kit – English/INTL (English)	1	1079424	989805634361
NIVO Pro-X controller kit – INTL (Spanish, Italian, Portuguese, Greek)	1	1082696	989805634501

NIVO controller and system components

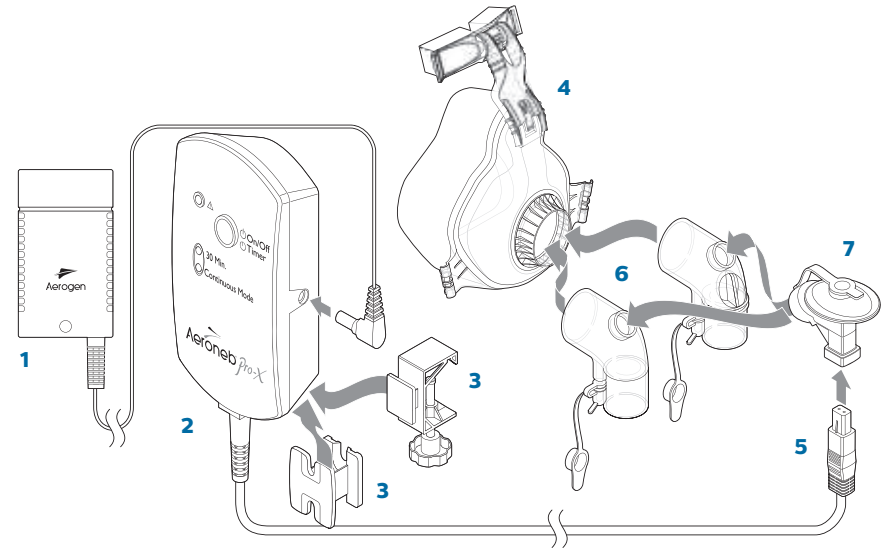

- 1** AC/DC adapter Power source or charge controller
- 2** Pro-X control module Can use AC/DC adapter or internal battery (up to 45 minutes)
- 3** Equipment mount Use for pole or humidifier slot mounting configuration
- 4** AF531 mask** Mask to be used
- 5** Control module cable Connect controller to NIVO nebulizer
- 6** Nebulizer elbows (NE) Entrainment elbow (EE) or standard elbow (SE) with nebulizer port
- 7** NIVO nebulizer Aerosol generator

* Pro-X nebulizer kit includes #1, 2, 3, and 5 shown above

** NE elbow can be added to an existing AF531 or mask can be purchased with NE elbow installed.

Mask accessories

Philips Respironics AF531 accessories and replacement parts

Description	Quantity	Product number	Part number
EE leak 1 entrainment elbow*	1	1072645	989805628841
EE leak 1 entrainment elbow*	5	1072646	989805628831
EE leak 1 nebulizing elbow (no nebulizer)*	1	1072649	989805634531
EE leak 1 nebulizing elbow (no nebulizer)*	5	1072650	989805634541
SE nebulizing elbow (no nebulizer)*	1	1076755	989805634561
SE nebulizing elbow (no nebulizer)*	5	1076754	989805634551
NIVO nebulizer	5	1076302	989805634301
CapStrap headgear with clips	1	1072654	989805628871
AF531 sizing gauge	25	1078287	989805628901
Swivel	1	7041	453561517051
RP-PMax and AF531 headgear clips	2	1060913	989805649921
Nasogastric sealing pad	10	452040	453561517091
CleanClip bracket assembly	1	1076430	989805627181
CleanClip bracket thumb screw	1	1076197	989805629911
Bronchoscopy elbow*	1	1072651	989805635091
Bronchoscopy elbow*	5	1072652	989805635101

Philips Respironics PerforMax accessories and replacement parts

Description	Quantity	Product number	Part number
EE leak 2 entrainment elbow*	1	1045313	989805611111
EE leak 2 entrainment elbow*	5	1072647	989805628851
Bronchoscopy elbow*	1	1072651	989805635091
Bronchoscopy elbow*	5	1072652	989805635101
SE standard elbow*	1	1043210	989805611081
SE standard elbow*	5	1072648	989805628861

* Elbow – Conical type: Push and twist to install. Pull and twist to remove. Refer to instructions with compatible mask or elbow for proper usage. Conical type elbows used on AF531, PerforMAX and PerforMAX pediatric mask.

Philips Respironics AF541 accessories and replacement parts

Description	Quantity	Product number	Part number
AF541 over-the-nose cushion, small	10	1120960	989805654131
AF541 over-the-nose cushion, medium	10	1120961	989805654141
AF541 over-the-nose cushion, large	10	1120962	989805654151
AF541 over-the-nose cushion, extra large	10	1120963	989805654161
EE leak 1 elbow with NIVO port**	5	1120967	989805654171
EE leak 2 elbow with NIVO port**	5	1120968	989805654181
SE standard elbow with NIVO port**	5	1120969	989805654191
AF541 EE leak 1, without cushion, four-point headgear	5	1120975	989805654201
AF541 EE leak 1, without cushion, CapStrap headgear	5	1120976	989805654211
AF541 four-point headgear with forehead pad, small/medium	5	1120970	989805654221
AF541 four-point headgear with forehead pad, large/extra large	5	1120971	989805654231
AF541 CapStrap headgear, small/medium	5	1126500	989805654251
AF541 CapStrap headgear, large/extra large	5	1120972	989805654241
AF541 sizing gauge	25	1120977	989805654261
AF541 size A under-the-nose cushion	10	1120980	989805654271
AF541 size B under-the-nose cushion	10	1120981	989805654281
AF541 size C under-the nose cushion	10	1120982	989805654291
Bronchoscopy elbow	5	1120984	989805654301
AF541 discharge kit, CapStrap headgear, small/medium	5	1120986	989805654311
AF541 discharge kit, four-point headgear, small/medium	5	1120987	989805654321
AF541 discharge kit, CapStrap headgear, large/extra large	5	1120988	989805654331
AF541 discharge kit, four-point headgear, large/extra large	5	1120989	989805654341

** Elbow – Snap/Squeeze type: Push for audible click to install and squeeze tabs to remove. Refer to instructions with compatible mask or elbow for proper usage. Snap/Squeeze type used on AF541 mask.

Headgear

Image	Description	Size	Compatibility	Quantity	Product number	Part number
1	CapStrap headgear with ball and socket clips	Adult (one size)	AF811, PerformaTrak	5	1019543	989805610841
1	CapStrap headgear with clips	Adult (one size)	AF531	1	1072654	989805628871
2	Four-point headgear with ball and socket clips	Adult (one size)	AF811, PerformaTrak	1	1015788	989805610221
3	Four-point headgear, no clips	Petite	AF811, PerformaTrak Contour Deluxe	5	1018472	989805610351
3	Four-point headgear, no clips	Adult (one size)	AF811, PerformaTrak Contour Deluxe	5	1007365	989805609961
4	Four-point headgear	Adult (one size)	Total	1	1003052	453561517111
4	Four-point headgear	Adult (one size)	Total	9	1010609	989805610031
5	Four-point headgear	Adult (one size)	Vinyl nasal	10	312106	989805609291
6	Four-point headgear with crown strap, clips	Small	PerforMax	5	1051857	989805611231
6	Four-point headgear with crown strap, clips	Large	PerforMax	5	1051816	989805611221
6	Four-point headgear with crown strap, clips	Extra large	PerforMax	5	1080518	989805634851
6	Four-point headgear with crown strap, clips	Small	PerforMax	9	1045325	989805611131
6	Four-point headgear with crown strap, clips	Large	PerforMax	9	1045314	989805611121
6	Four-point headgear with crown strap, clips	Extra large	PerforMax	9	1080519	989805634861
6	Four-point headgear with crown strap, clips	Small	AF531	1	1072655	989805628891
6	Four-point headgear with crown strap, clips	Large	AF531	1	1072656	989805628881
6	Four-point headgear with crown strap, clips	Extra large	AF531	5	1083188	989805634751
7	Two-point headgear with chin strap	Adult (one size)	AP111	5	1062134	453561516551
8	AF421 forehead pad kit with two pads	10 mm	AF421	10	1119366	989805652521
*	Four-point headgear assembly with forehead pad	Adult (one size)	PerformaTrak multi-use only	5	1022453	989805610861
9	AF541 four-point headgear with forehead pad	Small/Medium	AF541	5	1120970	989805654221
9	AF541 four-point headgear with forehead pad	Large/Extra large	AF541	5	1120971	989805654231
10	AF541 CapStrap headgear	Small/Medium	AF541	5	1126500	989805654251
10	AF541 CapStrap headgear	Large/Extra large	AF541	5	1120972	989805654241

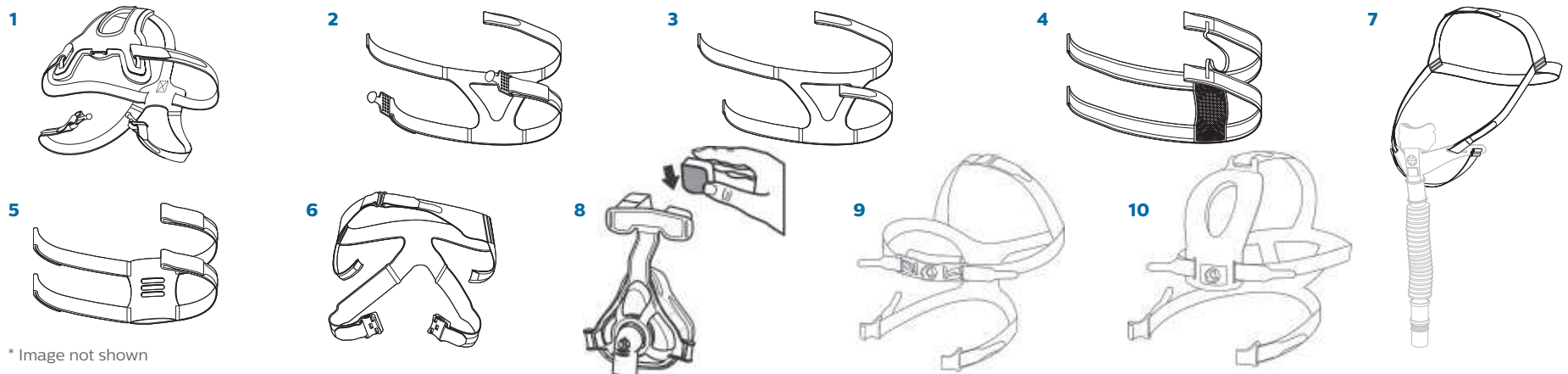

* Image not shown

Circuit and mask components and accessories

Image	Description	Quantity	Product number	Part number
1	Plateau exhalation valve (reusable)	1	302312	989805617941
2	Plateau exhalation valve diaphragm	5	302310	989805609221
3	Whisper Swivel II	1	332113	989805617951
4	Disposable exhalation port with filter exhalation port with swivel (no filter)	10	1065775	453561517211
4a	Replacement port caps (silicone)	5	1061825	453561517201
4b	Disposable exhalation port with filter exhalation port and proximal pressure line (7 ft, 2.1 m)	10	1116891	989805652291
4b	Disposable exhalation port with filter exhalation port and proximal pressure line (7 ft, 2.1 m)	1	1116892	989805652301
5	Disposable exhalation port	10	312149	989805609391
6	Oxygen enrichment attachment	1	312710	989805609421
6	Oxygen enrichment attachment	10	312010	989805609241
7	Bacteria/virus filter (single use)	1	1014047	989805618161
7	Bacteria/virus filter (single use)	10	342077	989805609521
8	Proximal airway filter	1	1002362	453561517101
9	Tube management clip	2	1039967	453561517351

1

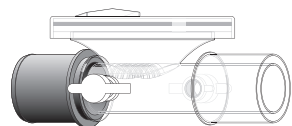

2

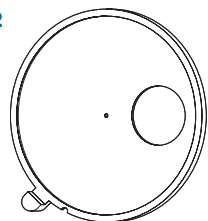

3

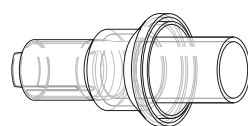

4, 4a

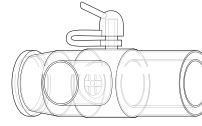

4, 4b

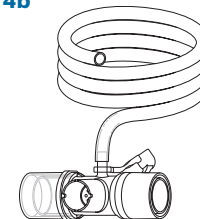

5

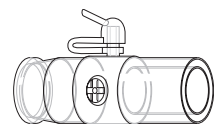

6

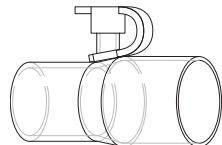

7

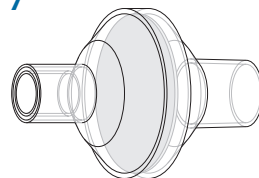

8

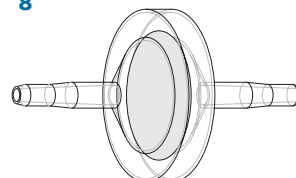

9

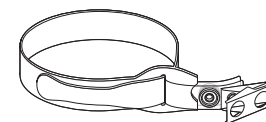

Circuit and mask components and accessories

Image	Description	Quantity	Product number	Part number
10	Swivel replacement kit (22 mm male-male)	1	7041	453561517051
11	CleanClip bracket assembly	1	1076430	989805627181
11	CleanClip bracket thumb screw	1	1076197	989805629911
12	Nasogastric tube sealing pad	10	452040	453561517091
13	PerforMax sizing gauge, small, large, and extra large	1	1095097	989805648901
14	Replacement ball and socket	2	1009723	989805652511

10

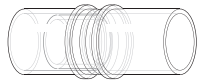

11

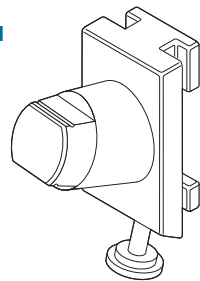

12

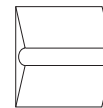

13

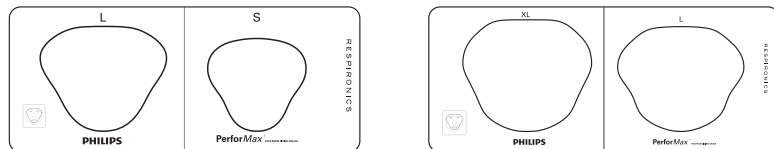

14

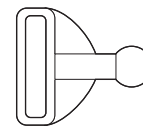

* Image not shown

Circuits and connections

Philips offers a variety of single-use circuits, including heated-wire and non-heated-wire options, to accompany our noninvasive ventilation systems.



Circuits

Image	Description	Product number	Part number	Quantity	V60	BiPAP Vision	Trilogy 202	BiPAP Focus	BiPAP S/T-D
1	Invasive circuit with exhalation port, water trap and temperature probe ports, proximal airway filter and humidifier coupling tube, hanger, and hose clips	652002	989805609681	10	.	.	.		
1	Invasive circuit with exhalation port, water trap and temperature probe ports, proximal airway filter and humidifier coupling tube, hanger, and hose clips	652001	989805609671	20	.	.	.		
2	Noninvasive circuit with main flow filter, disposable swivel exhalation port with filter port and filter, proximal pressure line, hanger, and hose clips	1065830	989805621311	10	
3	Noninvasive circuit with main flow filter, disposable swivel exhalation port with filter port, proximal pressure line, hanger, and hose clips (exhalation filter not included)	1065832	989805621321	10	
4	Noninvasive circuit with disposable swivel exhalation port with filter port, proximal pressure line, hanger, and hose clips (main flow and exhalation filters not included)	1069210	989805634871	10	
5	Noninvasive circuit with disposable exhalation port, proximal pressure line, hanger, and hose clips	582073	989805609611	10	
6	BiPAP S/T-D circuit with exhalation port, proximal pressure line, hanger, and hose clips	312107	989805609301	10					.
7	Tubing 6 ft (22 mm) (no dep, proximal pressure line, or hanger)	532316	989805647181	1					

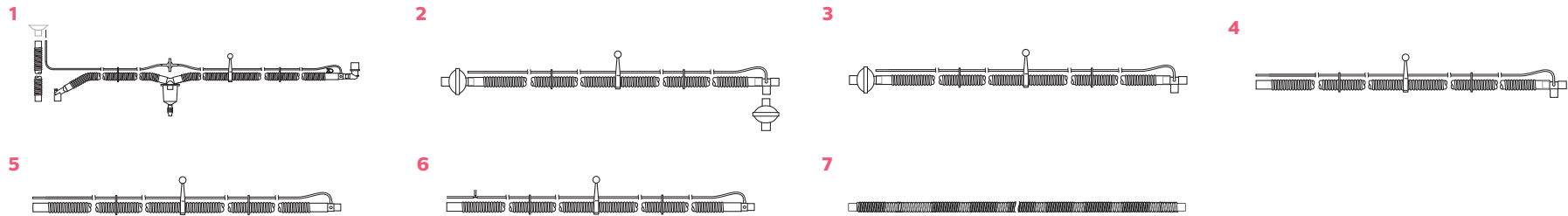

Humidification circuits and accessories

Description	Quantity	Product number	Part number
Auto-feed humidification chamber	24	1035609	989805619481
Heated single-limb circuit with main flow filter	10	8624C	989805619521
Heated single-limb circuit with main flow filter, auto-feed humidification chamber	10	1045770	989805619511

Dry circuits and accessories

Description	Quantity	Product number	Part number
NIV circuit with main flow filter	10	9624	989805619411
NIV circuit with main flow filter, O ₂ , enrichment port	10	9624C	989805619531

Trilogy accessories

The innovative technology of Trilogy sets it apart from the rest. The support, service, and upkeep behind it keep it there.

Easy to use and maintain

- Trilogy circuits can be used for a variety of pediatric and adult patient applications
- Passive circuits for NIV applications
- Active exhalation valve for IV application
- Circuits are available in packs of 10 and 20



Circuit adapters

Image	Description	Compatibility	Product number	Part number
1	Active exhalation valve with PAP assembly		1065659 – 1/pk	989805628221
2	Proximal flow sensor (Trilogy202)		1050408 – 1/pk 1050534 – 10/pk	989805621211 989805645511
3	Disposable swivel passive exhalation port		1084428 – box of 10 1084429 – box of 20	989805643161 989805646961
4	Flexible trach adapter with 15 mm cuff	Connects to the flow sensor or the active exhalation valve	1073863 – box of 10 1073903 – box of 20	989805633921 989805633941
5	Flexible trach adapter with 22 mm cuff	Connects to Whisper Swivel II and swivel and fixed disposable exhalation ports	1073902 – box of 10 1073904 – box of 20	989805633931 989805633951

The ability to use either an active valve or passive exhalation port gives you the flexibility to choose the best available circuit and interface for your patient. Trilogy's unique passive exhalation port reduces extra tubing connections.

1

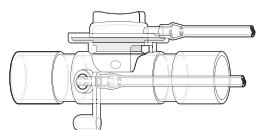

2

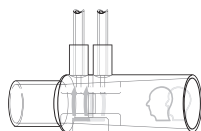

3

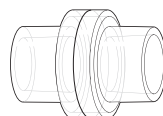

4

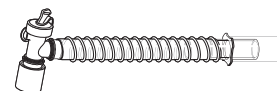

5

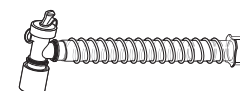

Miscellaneous

Image	Product	Product number	Part number
6	Oxygen inlet adapter – 2/pk	1040390	989805647691
7	Tube port adapter, active PAP	1061398	989805621291

6

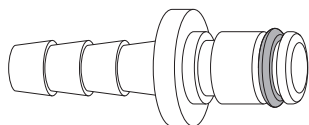

7

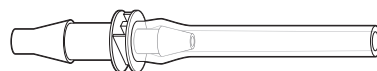

Trilogy support arm system

Image	Product	Product number	Part number
8	Tubing hanger (22 mm) – 1/pk	311107	989805648891
*	Support arm	332497	989805617961
*	Support arm mount assembly	1052863	989805605731

8

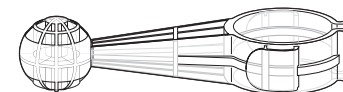

* Image not shown

Trilogy disposable circuits

Image	Description	Components	Quantity	Product number	Part number
1	Adult passive circuit with fixed exhalation port	Passive exhalation port. Patient tube: 6 ft length, 22 mm diameter with 22 mm cuff.	Box of 10	1069467	989805621551
			Box of 20	1069468	989805621561
2	Adult passive circuit with swivel design exhalation port	Passive exhalation port. Patient tube: 6 ft length, 22 mm diameter with 22 mm cuff.	Box of 10	1073228	989805633861
			Box of 20	1073236	989805633911
3*	Adult passive circuit with water trap	Standard 90° degree elbow adapter. Passive fixed exhalation port. Temperature probe port. Patient tube, 2 ft length, 22 mm diameter with 22 mm cuff. Water trap. Humidifier connection tube, 2 ft length, 22 mm diameter with 22 mm cuff.	Box of 10	1069443	989805621531
			Box of 20	1069444	989805621541
4*	Adult passive circuit, heated wire	Passive swivel exhalation port. Temperature probe port. Heated wire patient tube, 5 ft length, 22 mm diameter with 22 mm cuff. Heated wire adapter. Humidifier connection tube, 2 ft length, 22 mm in diameter with 22 mm cuff.	Box of 10	1073227	989805646441
			Box of 20	1073235	989805646481
5	Adult active circuit, no water trap	Standard 90° elbow trach adapter. Active exhalation valve. Exhalation tubing. Proximal pressure tubing. Patient tube, 6 ft length, 22 mm diameter with 22 mm cuff. Tube management clips.	Box of 10	1073223	989805633841
			Box of 20	1073232	989805633881
6*	Adult active circuit, heated wire	Standard 90° elbow trach adapter. Active exhalation valve. Exhalation tubing. Proximal pressure tubing. Heated wire patient tube, 5 ft length, 22 mm diameter with 22 mm cuff, with heated wire connector. Heated wire adapter. Temperature probe port. Humidifier connection tube, 2 ft length, 15 mm diameter with 22 mm cuff. Tube management clips.	Box of 10	1073222	989805646421
			Box of 20	1073231	989805646461

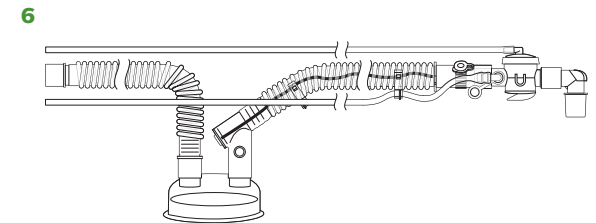
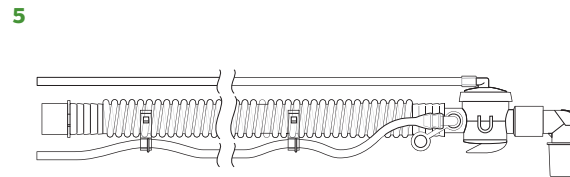
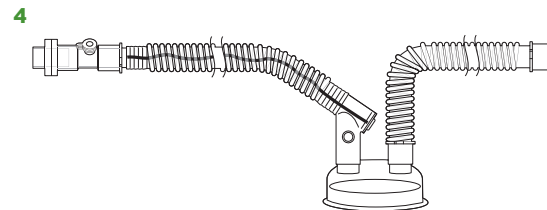
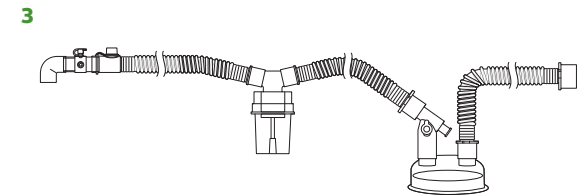
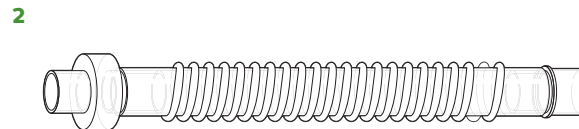
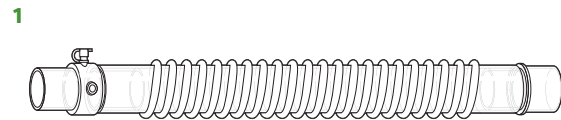

* Chamber not included

Trilogy disposable circuits

Image	Description	Components	Quantity	Product number	Part number
7	Pediatric passive circuit with water trap	Passive fixed exhalation port. Patient tube, 6 ft length, 15 mm diameter with 22 mm cuff and water trap.	Box of 10	1069445	453561517231
			Box of 20	1069446	453561517241
8*	Pediatric passive circuit with water trap	Passive swivel exhalation port. Patient tube, 2.5 ft length, 15 mm diameter with 22 mm cuff. Temperature probe port. Water trap. Humidifier connection tube, 2 ft length, 15 mm diameter with 22 mm cuff.	Box of 10	1073224	989805633851
			Box of 20	1073233	989805633901
9*	Pediatric passive circuit, heated wire	Passive swivel exhalation port. Heated wire patient tube, 5 ft length, 15 mm diameter with 22 mm cuff, with heated wire connector. Heated wire adapter. Temperature probe port. Humidifier connection tube, 2 ft length, 15 mm diameter with 22 mm cuff.	Box of 10	1073225	989805646431
			Box of 20	1073234	989805646471
10*	Pediatric active circuit with water trap	Standard 90° elbow trach adapter. Active exhalation valve. Exhalation tubing. Proximal pressure tubing. Patient tube, 2.5 ft length, 15 mm diameter with 22 mm cuff. Temperature probe port. Water trap. Humidifier connection tube, 2 ft length, 15 mm diameter with 22 mm cuff. Tube management clips (one shown).	Box of 10	1073220	989805633831
			Box of 20	1073229	989805633871
11*	Pediatric active circuit, heated wire	Standard 90° elbow trach adapter. Active exhalation valve. Exhalation tubing. Proximal pressure tubing. Heated wire patient tube, 5 ft length, 15 mm diameter with 22 mm cuff, with heated wire connector. Heated wire adapter. Temperature probe port. Tube management clips. Humidifier connection tube, 2 ft length, 15 mm diameter with 22 mm cuff.	Box of 10	1073221	989805646411
			Box of 20	1073230	989805646451
12	MPV (mouthpiece ventilation) circuit, single use	Bacteria filter, 22 mm x 15 mm reducer cuff, 6 ft length, 15 mm tubing, coupler, miniature and angled mouthpiece.	Box of 10	1102866	989805646981

7

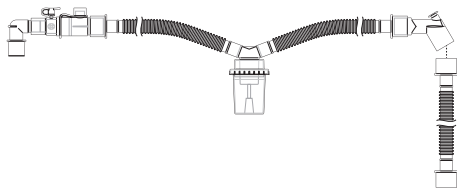

8

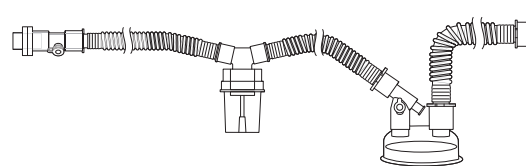

9

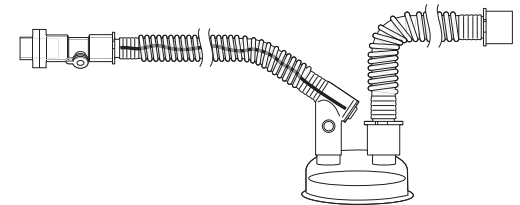

10

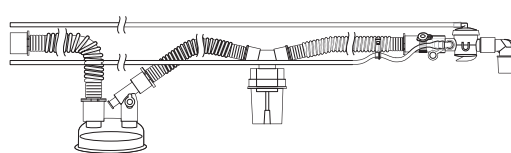

11

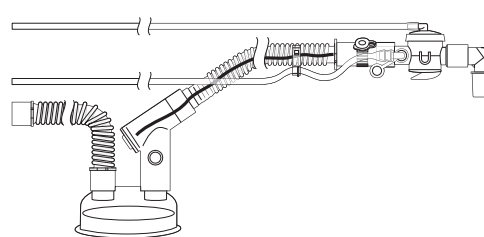

12

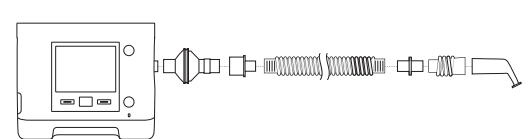

* Chamber not included



Notes

Notes

©2016 Koninklijke Philips N.V. All rights are reserved.
Philips reserves the right to make changes in specifications and/or to discontinue any product at any time without notice or obligation and will not be liable for any consequences resulting from the use of this publication. Trademarks are the property of Koninklijke Philips N.V. or their respective owners.



www.philips.com/NIVmasks

Printed in the Netherlands.
4522 991 16521 * AUG 2016